

Dell XC630 Web-Scale Hyperconverged Appliance Solutions Guide



Notes, cautions, and warnings

 **NOTE:** A NOTE indicates important information that helps you make better use of your computer.

 **CAUTION:** A CAUTION indicates either potential damage to hardware or loss of data and tells you how to avoid the problem.

 **WARNING:** A WARNING indicates a potential for property damage, personal injury, or death.

© 2016 Dell Inc. All rights reserved. This product is protected by U.S. and international copyright and intellectual property laws. Dell and the Dell logo are trademarks of Dell Inc. in the United States and/or other jurisdictions. All other marks and names mentioned herein may be trademarks of their respective companies.

2016 - 05

Rev. A04

Contents

1 About Dell Web-Scale Converged Appliance solution.....	5
2 Supported hardware, firmware, and software.....	6
3 Documentation references.....	7
4 Licensing overview.....	8
Starter license.....	8
Pro and Ultimate licenses.....	8
Setting up Nutanix Customer Portal.....	8
Managing your Nutanix license.....	9
5 Deploying your system.....	10
Important information about SATADOM.....	10
Examples of write intensive applications.....	10
Before you begin.....	11
Setting up your Dell XC630 for first use.....	11
Boot error message for missing SD card.....	12
Deployment outline.....	12
Default cluster credentials.....	14
6 Downloading and installing Software applications.....	16
Installing Dell OpenManage Essentials on a separate server.....	16
Dell Nautilus	17
7 Monitoring.....	18
Monitoring software.....	18
8 Updating firmware.....	20
Updating drive firmware with Dell Nautilus.....	20
9 Replacing hardware.....	22
Replacing components with no cluster data.....	22
Replacing failed front HDD and SSD components that contain cluster data.....	22
10 Recovering system.....	24
11 Getting help.....	25
Contacting Dell.....	25

Dell SupportAssist.....	25
Locating Service Tag.....	25
Quick Resource Locator.....	26

About Dell Web-Scale Converged Appliance solution

Dell provides a web-scale converged appliance solution that includes the Dell XC630 server and software from Nutanix (used as a virtual appliance), which simplifies virtualization by converging computer, storage, and network into a single appliance that is deployed in a clustered environment. The following figures show the Dell XC630. For more information about the Dell XC630 system, see the *Dell XC630 Owner's Manual* available at Dell.com/xcseriesmanuals.



Figure 1. Front view of Dell XC630



Figure 2. Back view of Dell XC630

Supported hardware, firmware, and software

For a list of the most up-to-date supported hardware, firmware, and software, see the *Dell XC630 Web-Scale Converged Appliance Support Matrix* available at [Dell.com/xcseriesmanuals](https://www.dell.com/xcseriesmanuals).

Documentation references

For information about the Dell documents, see the Support Matrix specific for your product.

For information about the Nutanix documents that applies to a specific release of Nutanix solution software, see the Support Matrix specific for your product.

Licensing overview

The Nutanix virtual computing platform includes various features that allow you to administer your environment according to your current and future requirements.

You can use the default feature set of the Nutanix solution software, upgrade to an enhanced feature set, update your license for a longer term, or reassign existing licenses to nodes or clusters as required.

Starter license

Each Nutanix node and block is delivered with a default Starter license, which is issued for a six-year term that begins at the shipping date for your Dell XC630 order. You are not required to register this license on the Nutanix Customer Portal account assigned to you when you purchased your nodes.

Pro and Ultimate licenses

The Pro and Ultimate license types require you to download a license file from the Nutanix Customer Support Portal and install it on your cluster. When you upgrade to a Pro or Ultimate license, or add nodes or clusters to your environment with these licensed features, you must generate the license file, download it, and then install it.

 **NOTE:** The most current information about your license is available at the Nutanix Customer Support Portal. You can view information about license types, expiration dates, and any free license inventory (that is, unassigned available licenses).

Setting up Nutanix Customer Portal

If you are new to Nutanix Support, create a personal profile on the Nutanix Customer Portal. Creating a personal profile allows you to manage your licenses.

 **NOTE:** The Nutanix Customer Portal is also required to access some of the advanced Nutanix documentation.

To set up your Nutanix Customer Portal, complete the following tasks:

1. Go to the Nutanix Customer Portal at <http://portal.nutanix.com> and click **Register Now**.
2. Register by typing data in appropriate boxes.
3. In the **Serial Number** box, type the Service Tag number of your Dell XC630 system.

 **NOTE:** To find the Service Tag of your Dell XC630, see the Locating The Service Tag section in this document.

4. After the Customer Portal account is created, you can manage your licenses.







Managing your Nutanix license

For more information about license management, complete the following tasks:

1. On the Nutanix Documentation portal, see the *Web Console Guide* (for access details, see the Documentation matrix section in the Support Matrix).
2. In the Nutanix *Web Console Guide*, see the *License Management* section.
3. Perform the relevant licensing tasks for your system.

Deploying your system

Before you deploy your system, ensure that you read through this document and have yourself familiarized with the process and required materials.

-  **WARNING:** Before you set up and operate your Dell XC630, review the safety instructions that shipped with your storage enclosure.
-  **WARNING:** The weight of your system without the physical disk drives installed (empty weight) is 36.5 kg (80.5 lb).
-  **WARNING:** Your system must be installed by Dell certified service technicians.
-  **CAUTION:** Before installing your system in the rack, make sure that the weight of the system does not exceed the weight limit of the rack. For more information, see the Rack Installation instructions that shipped with your system.
-  **NOTE:** For weight stability, always load the rack by using bottom-up approach.
-  **NOTE:** This solution is deployed by Dell Services. The following deployment steps provide an outline of what Dell Services accomplishes during the deployment process.

Important information about SATADOM

The SATA Disk-On-Motherboard (SATADOM) shipped with XC Series appliances is intended as an appliance boot device.

-  **NOTE:** Write intensive activities and processes leveraged by XC appliances, are intended to take place on the SSDs and HDDs and not the boot device.

The hypervisor boot device is not intended for application use.

-  **WARNING:** Adding additional write intensive software to the SATADOM boot disk results in heavy wear on the device beyond design specifications resulting in premature hardware failure.

You should not run applications on the hypervisor operating system.

Examples of write intensive applications

Following are the examples of write intensive applications:

- System Center Agents
 - System Center Configuration Manager (CCMExec.exe)
 - System Center Operations Manager (MonitoringHost.exe)
- Write-intensive Agents
- Databases
- Disk management utilities (third-party disk defragmentation or partitioning tools)

- Additional roles outside of the appliance's intended use (web server, domain controller, RDS, and so on.)
- Client-based Antivirus
- Run Virtual Machines directly on the SATADOM.
- Run Virtual Machines from SSDs and HDDs only.

Before you begin

 **CAUTION:** It is important that you perform all the steps in this guide prior to doing other configuration steps.

Make sure that the following items are available:

- Power cables
- Network cables — optical and/or copper (Intel SFP+ or Category 6 Ethernet)
- Rail kit
- Nutanix documentation — *Setup Guide* and *Advanced Setup Guide*

 **NOTE:** For more information about the names of the guides for your version of the Nutanix solution software, see the Documentation matrix section in the Support Matrix.

- Dell Documentation — *Dell XC630 Web-Scale Converged Appliance Getting Started Guide*, *Dell XC630 Web-Scale Converged Appliance Solutions Guide*, *Rack Installation Instructions*, *Safety Instructions*, and *Dell XC630 Web-Scale Converged Appliance Support Matrix*

 **NOTE:** For information about locating required documents, see the Documentation matrix section in the Support Matrix.

Setting up your Dell XC630 for first use

1. Make sure that your system components are properly installed.
Your system is shipped with physical disk drives, power supply units (PSUs), and fan components already installed. Ensure that all components are properly seated and have not become dislodged and/or damaged during shipping.
2. Install the Dell XC630 in a rack.
The Dell XC630 requires a compatible rack and a rack installation kit. For information about installing the rails for the Dell XC630, see the *Rack Installation Instructions Guide* that shipped with your system.
3. Cable your solution based on the best practices cabling diagram shown here.

 **NOTE:** At a minimum, there are three Dell XC630 servers in a cluster. Each Dell XC630 is referred to as a node.

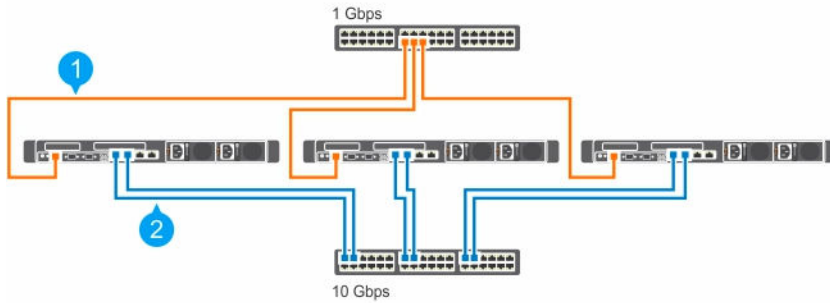



Figure 3. Cabling a system

1. Management Network
2. Host Network

 **NOTE:** The preferred (best practice) setup is to connect the management port across all three nodes to the same switch (management network).

Boot error message for missing SD card

The XC630 system has only one SD card. When you start the system, the following error message is displayed:

The secondary SD card is missing, not responding, or in write-protected mode. Do one of the following:

1. Install an SD card media in the secondary SD card slot.
2. Reseat or replace the SD card media.
3. If the secondary SD card is intentionally not installed or write-protected mode is expected, then no response is required.

The message is a known issue and you must ignore it.

Deployment outline

The flow of tasks in deploying the XC Series Web-Scale Converged Appliance is shown here.

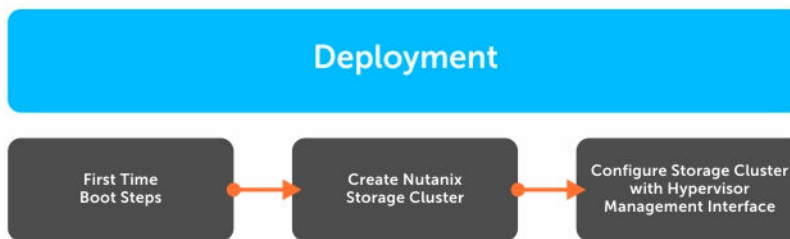



Figure 4. Deployment workflow process.

First time boot scripts for Nutanix Acropolis

Nutanix Acropolis nodes have been pre-configured and do not require additional first-time boot configuration. These nodes boot to the hypervisor and are ready to be clustered after the CVM has all services up and running.

First time boot scripts for VMware vSphere

Run the VMware vSphere first boot scripts on every node after they are properly racked and cabled. The first time boot scripts accomplish the following tasks:

 **NOTE:** These first time boot scripts run automatically upon the first boot of the system and include multiple reboots.

- Creates vSwitch Nutanix, internal and external port groups and vmkernel interface with address on internal portgroup.
- Activates vMotion and management on the default external vmkernel interface (vmk0).
- Enables TSM-SSH and TSM and allows sshClient, nfsClient, and ntpClient through the firewall.
- Denies vprobeServer through the firewall.
- Sets advanced ESXi parameters.
- Enables auto-start, sets the default RAM, and number of vCPU for the CVM.
- Elects applicable data-disk storage controller for PCI pass-through.
- Disables drivers associated with pass-through storage controllers.
- Installs the following VIBs: Nutanix VAAI, updated ixgbe and igb driver, and GPU VIBs (if applicable).
- Renames local VMFS datastore to standard naming convention: NTNX-local-ds-<block id>-<node_position>.
- Starts CVM and check for the existence of `/tmp/svm_boot_succeeded`.
- Restarts host.

First time boot scripts for Microsoft Hyper-V

Complete the Microsoft Hyper-V First boot scripts on every node after they are properly racked and cabled. The first time boot scripts accomplish the following tasks:

 **NOTE:** These first time boot scripts are run from a first time boot scripts wizard and require minimal user intervention.

- Sets up vSwitch or LBFO NIC Team
- Installs NIC drivers (Intel), Cygwin, ipmiutil, and Python
- Registers CVM as a VM
- Attaches Disks to CVM
- Enables auto-start, sets the default RAM and number of vCPU for the CVM.
- Starts CVM and checks for the existence of `/tmp/svm_boot_succeeded`.
- Restarts host.

Create Nutanix storage cluster

- Use the Nutanix web-based tool to create a Nutanix storage cluster from all locally discovered nodes that are ready to be clustered. During this process, the following parameters are set:
 - Cluster maximum Redundancy Factory (RF)
 - Cluster name
 - Cluster virtual IP (optional for AHV and vSphere)
 - Subnet mask and default gateway (iDRAC, hypervisor and CVM)
 - Domain Name Server(s) (DNS)
 - Network Time Protocol (NTP) servers (hypervisor NTP N/A for Hyper-V)

- Hypervisor hostnames
- Node IPs (iDRAC, hypervisor and CVM)
- Re-installation of new hypervisor and CVM (optional with Nutanix Foundation CVM)
- Option to create Nutanix storage cluster manually using command line interface.
 -  **NOTE:** In Acropolis base (NOS) 4.5, a new web-based clustering tool called Nutanix Foundation CVM replaces the earlier used cluster initialization page (deprecated). Nodes with Acropolis base (NOS) 4.5 or later installed in factory uses Nutanix Foundation CVM for initial deployment while those installed with NOS prior to Acropolis base (NOS) 4.5 will continue to use the traditional cluster initialization page.

Configure Nutanix storage cluster using hypervisor management GUI

-  **NOTE:** For information about document name, see the Nutanix documentation section in the Support Matrix. The document name varies depending on the solution software version you are running.

Acropolis Hypervisor (AHV):

- Create storage pool and containers through the Nutanix web console.
- Create, deploy, and manage virtual machines through the Nutanix web console.
- For more information, see the *Acropolis Virtualization Administration Guide*.

VMware vSphere:

- Create storage pools through the Nutanix web console.
- Create and mount containers as NFS datastores on appropriate hosts through the Nutanix web console.
- Manually add and configure vSphere clusters by using the Nutanix guidelines. For more information, see the *vSphere Administration Guide*.

Microsoft Hyper-V:

- Create storage pools and containers through the Nutanix web console.
- Run Hyper-V setup script from any CVM to join hosts to a domain, create a Hyper-V failover cluster, and register a storage cluster as an SMB share.
- Optionally, add a cluster to System Center Virtual Machine Manager either with the Hyper-V setup script or manually.

Default cluster credentials

The default cluster credentials for the system differ from those stated at the beginning of all Nutanix documentation. See Table 3 for default cluster credentials, which are specific to the system.

-  **NOTE:** The default password is not set for ESXi hosts.

Table 1. Default Cluster Credentials

Interface	Target	Username	Password
Web management console	iDRAC	root	calvin
SSH client or console	AHV host	root	nutanix/4u

Interface	Target	Username	Password
Remote desktop or console	Hyper-V host	Administrator	nutanix/4u
SSH client or console	ESXi host	root	
SSH client	Nutanix Controller VM	nutanix	nutanix/4u
Nutanix Web Console	PRISM Interface (after cluster configuration)	admin	admin

Downloading and installing Software applications

OpenManage Essentials is a hardware management application on a separate server that provides a comprehensive view of the Dell XC630 and its components. OpenManage Essentials enables you to:

- Discover and list the system inventory
- Monitor the health of a system
- Perform system updates and remote tasks
- View hardware inventory and compliance reports

For information about the supported OpenManage Essentials versions, see the Supported hardware, firmware, and software section in this document.

To download OpenManage Essentials management software, go to **Dell.com/support/home** or the Dell TechCenter website at **DellTechCenter.com/OME**.

To download the *OpenManage Essentials User's Guide*, go to **Dell.com/openmanagemanuals**.

 **NOTE:** To install OpenManage Essentials, you must have local system administrator privileges, and the system you are using must meet the criteria mentioned in the Installation Prerequisites and Minimum Requirements section of the *OpenManage Essentials User's Guide*.

 **NOTE:** OpenManage Essentials must be installed on the management network or a network that has access to the IMPI or iDRAC ports.

Installing Dell OpenManage Essentials on a separate server

To install OpenManage Essentials:

1. Go to **Dell.com/openmanagemanuals** and open the *OpenManage Essentials User's Guide*.
2. Go to the Installation Prerequisites and Minimum Requirements section and complete the tasks as described.
3. Go to the Installing OpenManage Essentials section and complete the tasks as described.
4. Install the following optional software applications:
 - Dell OpenManage Essentials
 - Dell Repository Manager

 **NOTE:** Install Dell Repository Manager only if you want to customize the Firmware Bundles and Update Packages.

- Documentation

Dell Nautilus

Dell Nautilus is a general maintenance release utility for updating firmware for SAS and SATA drives (or disks).

For information about the supported Dell Nautilus version number, see the Supported hardware, firmware, and software section in this document.

To download the Dell Nautilus Firmware Update Utility for SAS and SATA disk Solid State Drives (SSDs):

1. Go to **Dell.com/support/drivers**.
2. Under the **Customized support** section, in the **Enter your Service Tag or Express Service Code** box, type the Service Tag of your Dell XC630, and then click **Submit**.
 **NOTE:** If you do not have a Service Tag, select **Detect My Product** to allow the system to automatically detect your Service Tag, or select **Choose from a list of all Dell products** to select your product from the **Product Selection** page.
3. On the **Product Support** page, click **Drivers & downloads**.
4. From the **Operating System** drop-down menu, select **Not Applicable**.
5. Go to the **SAS Drive** section.
6. Search for Dell Nautilus Firmware Utility for SAS and SATA disk and SSDs.
7. Click **Download**. Click **Download** again to download the .exe file. In your Download folder, locate the latest version of Dell Nautilus and click to expand the compressed files.
8. In the extracted folder, run the USBMake Utility.
9. Create the bootable Nautilus package and perform one of the following tasks:
 - To create a bootable CD or DVD image (ISO), click Create Bootable CD Image and follow instructions. Burn the .iso image file to CD or save the bootable ISO on a management workstation.
 - Connect a USB flash drive to the system and follow instructions to create a bootable USB flash drive.

Monitoring

Table 2. System component monitoring guide

System Components	Monitor Utility
System memory	Dell OpenManage Essentials
Cooling fans	Dell OpenManage Essentials
Network Daughter Card	Dell OpenManage Essentials
Processors	Dell OpenManage Essentials
PSUs	Dell OpenManage Essentials
NIC	Dell OpenManage Essentials
Dell PERC 730 Mini or HBA330 mini	Dell OpenManage Essentials
Front HDDs	Nutanix web console
Front SSDs	Nutanix web console

 **NOTE:** For instructions about using Dell OpenManage Essentials to monitor the Dell XC630 system, do the following:

1. See the *OpenManage Essentials User's Guide*.
2. For information about discovering components of a Dell XC630 system, see the Discovering and Inventorying Devices section.
3. To use the functionality of OMSA preinstalled on each node, configure it by using the *OpenManage Essentials User's Guide*.
4. To add Dell XC630 to the discovered list of systems, discover Dell XC630 by using an IP range.

Monitoring software

To monitor the health of a cluster, VMs, performance, and alerts and events, the Nutanix web console provides a range of status-check features.

For more information about monitoring with the Nutanix web console, view the *Web Console Guide* document on the Nutanix documentation portal (for more information, see Documentation Matrix section in the Support Matrix).

In the *Nutanix Web Console Guide* document, see the following sections:

- Health Monitoring
- Virtual Machine Monitoring
- Performance Monitoring
- Alert and Event Monitoring

Updating firmware

Table 3. System component update guide

System components	Utility
Network Daughter Card	Dell OpenManage Essentials
PSUs	Dell OpenManage Essentials
NIC	Dell OpenManage Essentials
BIOS	Dell OpenManage Essentials
iDRAC	Dell OpenManage Essentials
Dell PERC H730 Mini or HBA330 mini	Dell OpenManage Essentials
Front HDDs	Nutanix web console
Front SSDs	Nutanix web console
SATADOM	Contact Dell Support

To update the firmware of the discovered system components, use Dell OpenManage Essentials. For instructions about using Dell OpenManage Essentials to monitor and update the discovered components of the Dell XC630 system, see *Updating Server BIOS, Firmware, Drivers, and Applications* in the *OpenManage Essentials User's Guide*.

 **NOTE:** Dell Nautilus may be used as an alternative to the Nutanix web console for updating firmware of the front HDDs and SSDs.

Updating drive firmware with Dell Nautilus

To update disk firmware with Dell Nautilus:

1. Turn off Controller Virtual Machine (CVM).
For information about how to turn off a node, see the *Nutanix Hardware Replacement* document.
2. Put hypervisor in Maintenance mode.
3. Access system GUI, and do one of the following:
 - Connect the physical keyboard or monitor or mouse to the ports on the Dell XC630.
 - Connect to the iDRAC GUI.

 **NOTE:** For information about configuring and accessing the iDRAC GUI, see the *iDRAC Quick Start Guide* at Dell.com/support/home.

4. Mount the Dell Nautilus ISO or the USB key to the system using virtual media.
5. While restarting the server, press F11 to open BIOS boot manager.
6. From the list, select **EFI Boot Manager**.
7. From the **EFI boot** list, select **Virtual CD** or the **USB drive**.
8. To update drive firmware, click **Update Firmware**.

 **NOTE:** Dell Nautilus updates all HDD and SSD firmware for all HDDs and SSDs connected to the system.

Replacing hardware

This section describes high-level tasks to replace components correctly within the Dell XC630 solution.

Before you begin, for information about downloading the following required documents for the three hardware replacement tasks, see the Documentation matrix section in the Support Matrix. The documents are:

- *Hardware Replacement Documentation*
- *Dell XC630 Web-Scale Converged Appliance Owner's Manual*

After you have these documents, you are ready to proceed with any of these hardware replacement tasks. To complete these tasks, you must see both the documents.

Replacing components with no cluster data

The hardware you can replace that involve no cluster data includes:

- System memory
 - Cooling fans
 - Network Daughter Cards or Network Interface Cards
 - PSUs
1. In the *Nutanix Hardware Replacement Guide*, see the Failure of Components that do not Contain Cluster Data section and turn off the node for the relevant hypervisor.
 2. In the *Dell XC630 Web-Scale Converged Appliance Owner's Manual*, see the Installing and removing system components section and replace the failed component.
 3. See the *Nutanix Hardware Replacement Documentation*, see the Failure of Components that do not Contain Cluster Data section, and then restart the node of the relevant hypervisor.

Replacing failed front HDD and SSD components that contain cluster data

To replace the failed front HDDs and SSDs that contain cluster data, do the following:

1. In the *Nutanix Hardware Replacement Documentation*, see the Data Drive Failure section and identify the failed HDD or SSD.
2. In the *Dell XC630 Web-Scale Converged Appliance Owner's Manual*, see the Installing and removing system components, HDDs, Removing a hot-swap hard drive, and Installing a hot-swap HDD sections.

 **NOTE:** New HDDs and SSDs being installed must have any foreign RAID configuration removed before being added to the system. Otherwise, they will not be recognized by the CVM.

3. See the *Nutanix Hardware Replacement Documentation* again, see the Completing Data Drive Replacement section and complete the replacement of the failed HDD or SSD.

Recovering system

For information about recovering your system, contact Dell Support.

Getting help

Contacting Dell

Dell provides several online and telephone-based support and service options. If you do not have an active internet connection, you can find contact information on your purchase invoice, packing slip, bill, or Dell product catalog. Availability varies by country and product, and some services may not be available in your area. To contact Dell for sales, technical assistance, or customer-service issues:

1. Go to **Dell.com/support**.
2. Select your country from the drop-down menu on the bottom right corner of the page.
3. For customized support:
 - a. Enter your system Service Tag in the **Enter your Service Tag** field.
 - b. Click **Submit**.The support page that lists the various support categories is displayed.
4. For general support:
 - a. Select your product category.
 - b. Select your product segment.
 - c. Select your product.The support page that lists the various support categories is displayed.
5. For contact details of Dell Global Technical Support:
 - a. Click [Global Technical Support](#).
 - b. The **Technical Support** page is displayed with details to call, chat, or e-mail the Dell Global Technical Support team.

Dell SupportAssist

For an enhanced Support Experience, Dell recommends installing and configuring Dell SupportAssist.

Dell SupportAssist is a software application that transparently collects information about your system and automatically creates support cases when issues are detected. Dell SupportAssist helps Dell to provide you an enhanced, personalized, and efficient support experience. Dell uses the data to solve common problem, designs and markets the products.

For more information about installing and configuring Dell SupportAssist, see: <http://www.dell.com/en-us/work/learn/supportassist-servers-storage-networking>.

Locating Service Tag

Your system is identified by a unique Express Service Code and Service Tag number. This information is used by Dell to route support calls to the appropriate service provider.

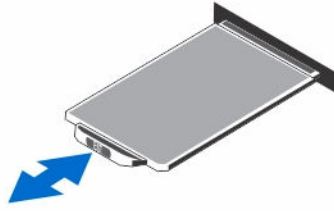

Figure 5. Locating service tag

Quick Resource Locator

Use the Quick Resource Locator (QRL) to get immediate access to system information and how-to videos. This can be done by visiting Dell.com/QRL or by using your smartphone or tablet and a model specific Quick Resource (QR) code located on your Dell system. To try out the QR code, scan the following image.



Figure 6. Quick Resource Locator